

M9111 SERIES

SINGLE-OUTPUT, UP TO 50W AC/DC POWER SUPPLY

M9111 series designed to universal input voltage (85V ac to 265V ac) and incorporated high power factor stage required in order to meet MIL-STD-461F to CE101 requirements and harmonic content lower than 1/N as required by MIL-STD 1399 (N is the number of the harmonic order).

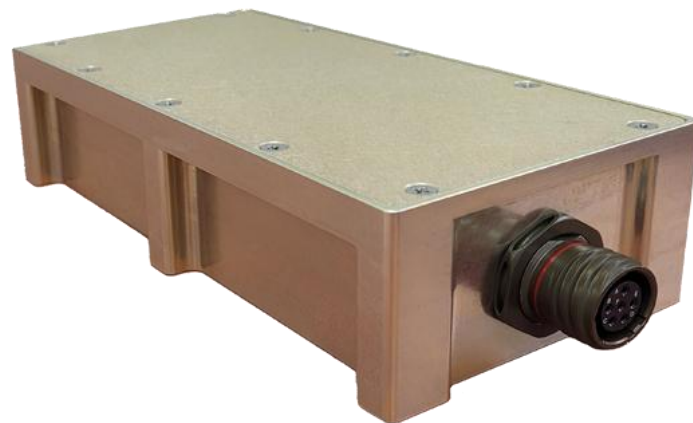

THE MAIN FEATURES OF THE M9111 ARE:

- AC/DC Single output power supply up to 50W
- 85V_{AC}-265V_{AC}/50-60Hz or 400Hz Standard Input version, single-phase
- High efficiency
- Wide input range
- High power factor (up to 98%)
- Input / Output isolation
- Sealed enclosure
- EMI filters included
- Inrush Current Limiter
- Non-latching protections:
 - Overload/Short-circuit
 - Output Overvoltage

M9111 Series– DC/DC Power Supply

Standard Models List (for other voltages – consult factory)

Part number	Input		Output	
	Voltage range	Frequency	Voltage	Current
M9111-100	85-265VAC/Single phase	50/60/400Hz	28V	1.7 A
M9111-101	85-265VAC/Single phase	50/60/400Hz	24V	2 A
M9111-102	85-265VAC/Single phase	50/60/400Hz	12V	4 A
M9111-103	85-265VAC/Single phase	50/60/400Hz	5V	10 A
M9111-104	85-265VAC/Single phase	50/60/400Hz	3.3V	15 A
M9111-800	85-265VAC/Single phase	50/60/400Hz	28V	1.7A
M9111-801	85-265VAC/Single phase	50/60/400Hz	24V	2 A
M9111-802	85-265VAC/Single phase	50/60/400Hz	12V	4 A
M9111-803	85-265VAC/Single phase	50/60/400Hz	5V	10 A
M9111-804	85-265VAC/Single phase	50/60/400Hz	3.3V	15 A

- Additional standard configurations available. **Contact factory for more details.**
- All of our products can be configured to comply with EU REACH regulations. **Contact factory for more details.**

For -8XX variants:

- This Product is REACH Compliant.
- The aluminum parts comprising this converter are chromate conversion coated per MIL-DTL-5541F, Type II CLASS 1A or eq.
- Connectors type:
J1 input: D38999/24ZA98PN or eq.
J2 output: D38999/24ZB98SN or eq.

M9111 Series– DC/DC Power Supply

SPECIFICATIONS:

AC Input	Voltage Range	Single-phase 85 to 265 VAC 50/60/400 Hz IAW MIL-STD-704F (115V/400Hz) For MIL-STD-1399-300B (Type I 115V/60Hz) - Please consult factory
	Isolation	Input to Output: 4242V DC Input to Case: 4242V DC** ** Safety components support IEC62368 requirements
	Inrush Current Limiter	EMI filter capacitance <1μF
DC Output	Rating	Additional standard configurations available. Contact factory for more details.
	Voltage Regulation	Less than 1% (no load to full load, -40 °C to +85 °C with recommended conduction cooling)
	Ripple and Noise	100 - 150 mVp-p typical (max 1%) with a 1μF ceramic capacitor parallel to the load.
	Isolation	Output to Case: 100 VDC
	Current Limit & Overload	Continuous protection (constant current) for unlimited time.
	Efficiency	82% Typical at 3.3V @ 20W output Vin 110V (appendix a) (at Vin≥110V input voltage, room temperature)
	Overvoltage Protection	Passive transorbs selected at 125% ± 15% of nominal voltage.

M9111 Series– DC/DC Power Supply

Specifications (Cont.):

Environment Designed to meet MIL- STD-810F	Temperature	Methods 501.4 & 502.4 Operating: –40 °C to +85 °C (at baseplate) Storage: –55 °C to +125 °C (ambient)
	Humidity	Method 507.4 Procedure I Up to 95% RH
	Salt-fog	Method 509.4
	Altitude	Method 500.4 Procedures I – Storage/Air transport: up to 70,000 ft. (non-operational) Procedure II – Operation/Air Carriage: up to 10,000 ft. (operational, consult factor for higher altitudes)
	Mechanical Shock	Method 516.5 20 g, 11 ms terminal peak saw-tooth
	Vibration	Method 514.5 U. S. highway truck vibration exposure Figure 514.5C-1 1 hour per axis.
IP	IP rating	For IP67 please consult factory
EMI	MIL-STD-461F	Designed to meet* MIL-STD-461F CE101, CE102, CS101, CS114, CS115, CS116, RE102, RS103, (Option for compliance with RE101, RS101)
Reliability	100,000 hours, calculated per MIL-STD-217F Notice 2 at +50°C ambient at sea level, Ground Fixed.	
Form factor	80mm wide, 45mm high and 160mm deep. For detailed dimensions and tolerances see Drawing: M9111001	
ESS	100% of delivered power supplies are tested at low ambient temperature, high baseplate temperature and at standard room temperature. Additional tests, such as random vibration and thermal cycling can be added. Please consult factory for details.	
Weight	700g typical	
Connectors	See Page 7	

* Compliance is dependent on specific configuration and is achieved when using a shielded enclosure and interconnection cable.

M9111 Series– DC/DC Power Supply

TEST RESULTS:

M9111-1 (3.3V_{DC}) typical efficiency and Power Factor at 110V_{AC} / 50Hz

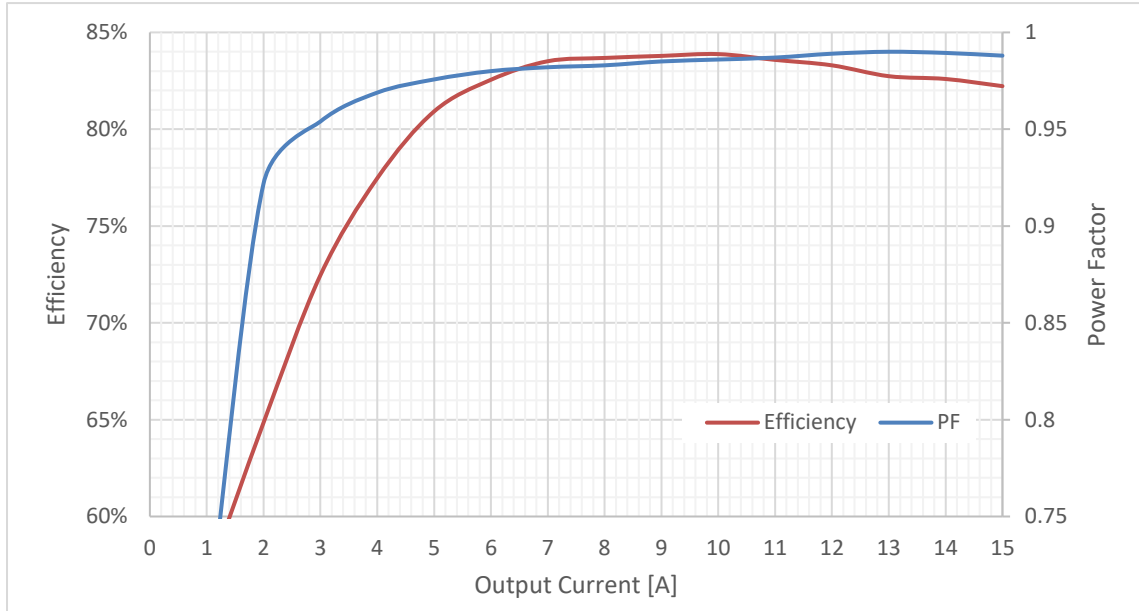

M9111-1 (3.3V_{DC}) typical efficiency and Power Factor at 220V_{AC} / 50Hz

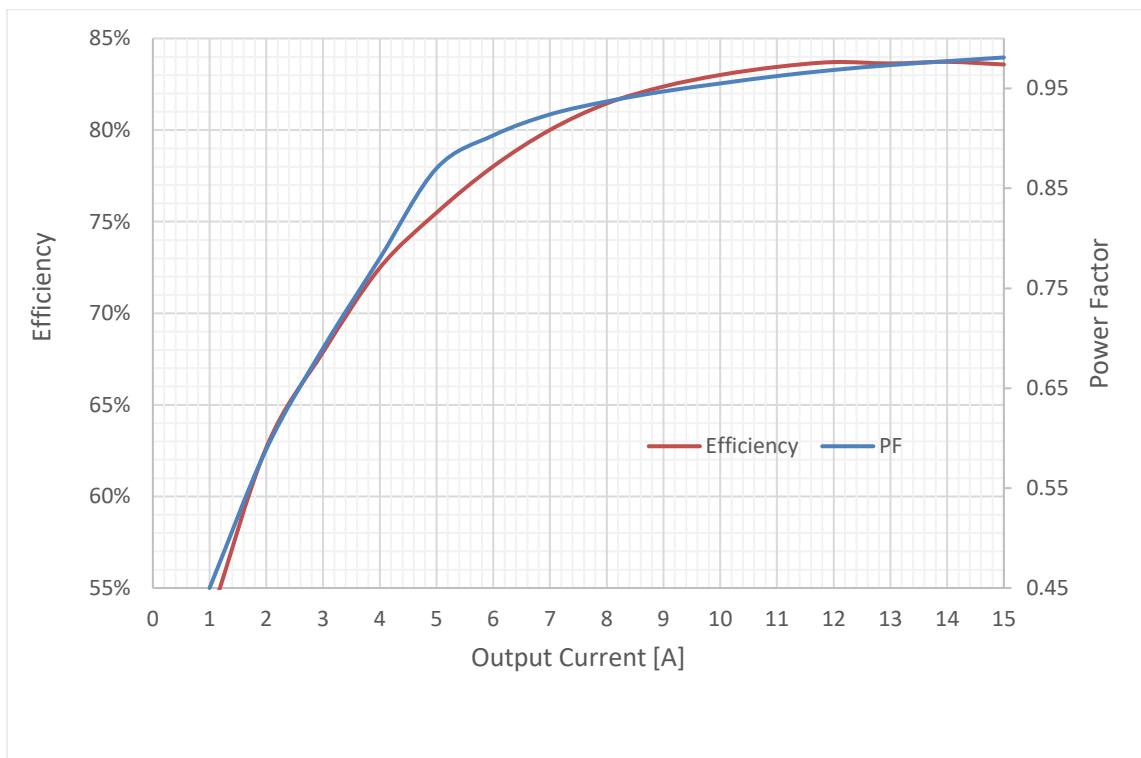

M9111 Series– DC/DC Power Supply

PIN ASSIGNMENT:

J1 - Input connector

Type:

D38999/24WA98PN

Mates with:

D38999/26WA98SN recommended.

Pin No.	Function	
A	PHASE	●
B	NEUTRAL	●
C	CHASSIS	●

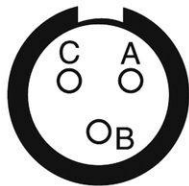

J2 - Output connector

Type:

D38999/24WB98SN

Mates with:

D38999/26WB98PN recommended.

Pin No.	Function	
A	OUTPUT	●
B	OUTPUT	●
C	OUTPUT	●
D	OUTPUT RTN	●
E	OUTPUT RTN	●
F	OUTPUT RTN	●

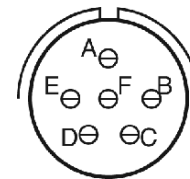

TYPICAL CONNECTION DIAGRAM

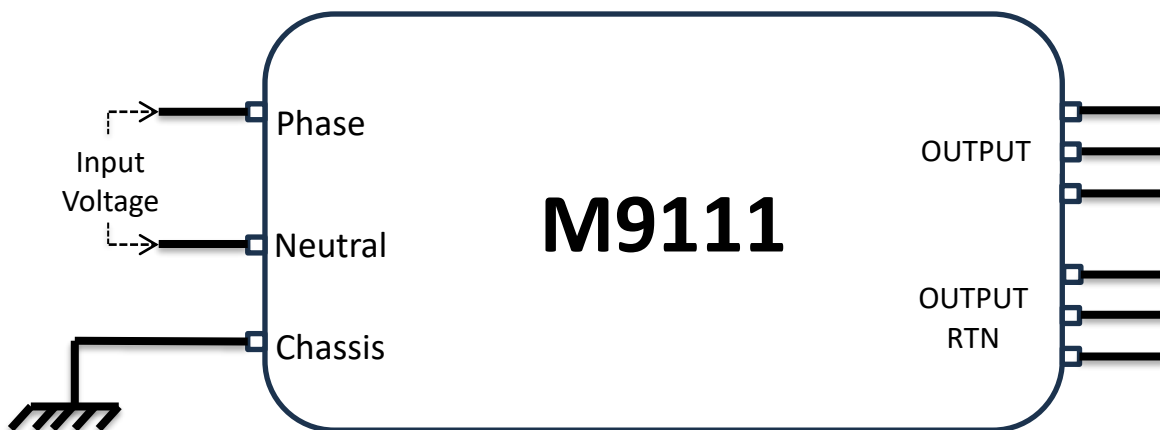

M9111 Series– DC/DC Power Supply

OUTLINE DRAWING:

For detailed dimensions and tolerances see Drawing: M9111001

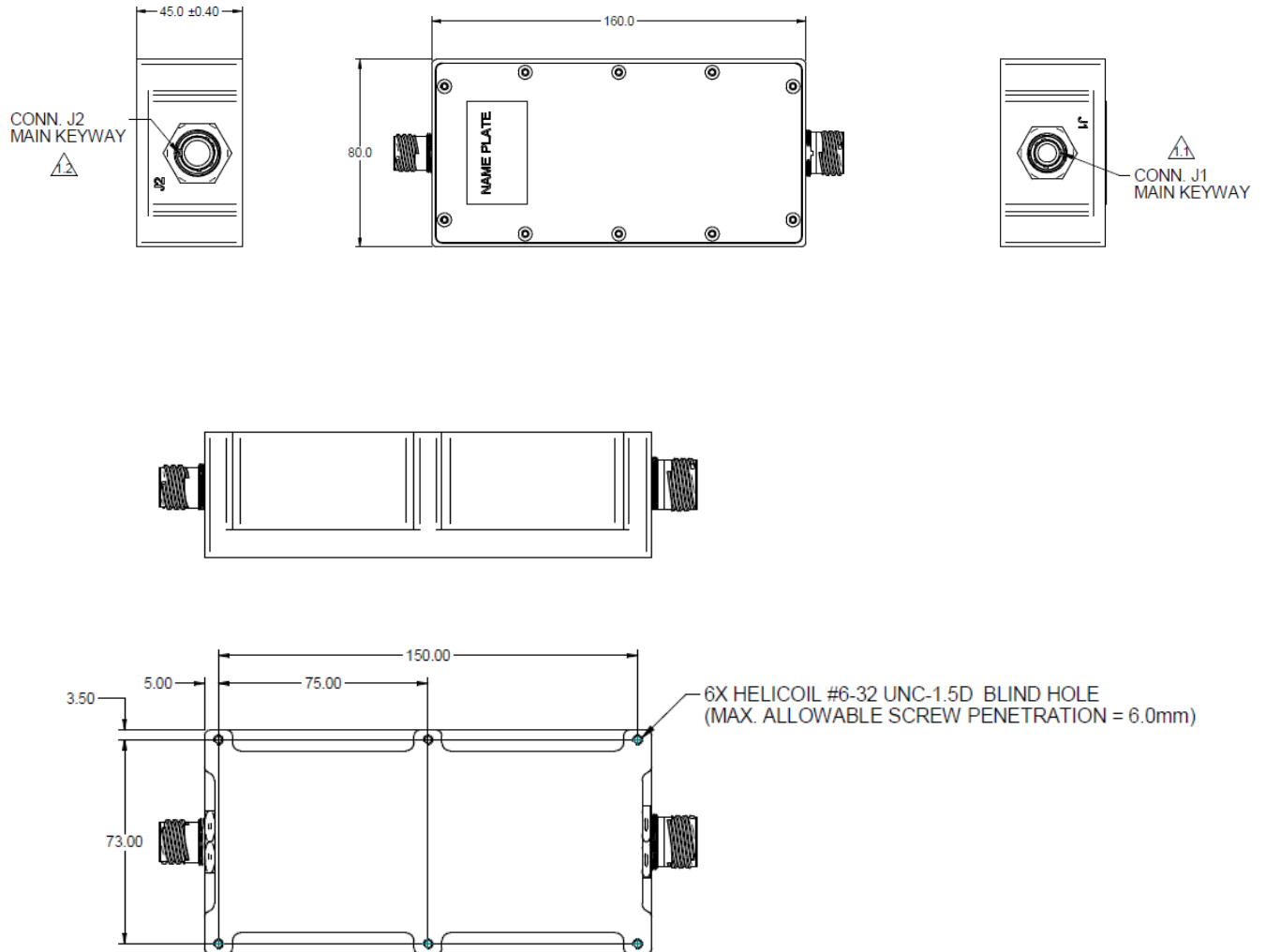

M9111 Series– DC/DC Power Supply

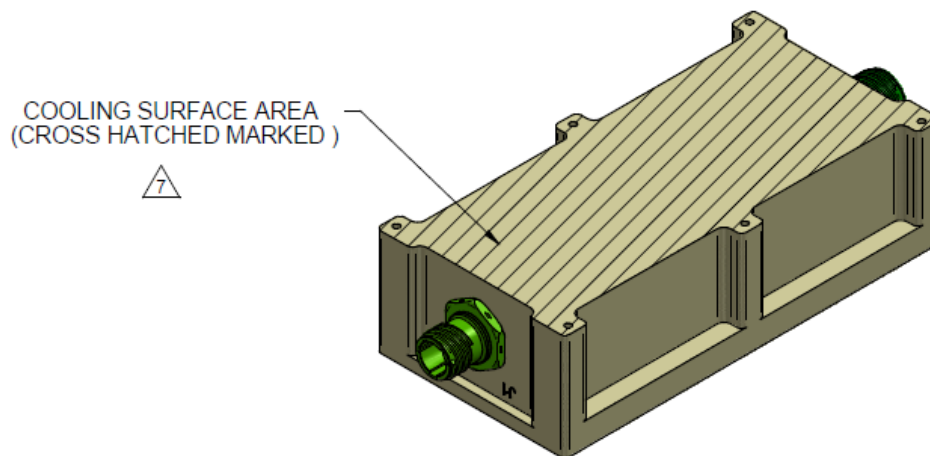
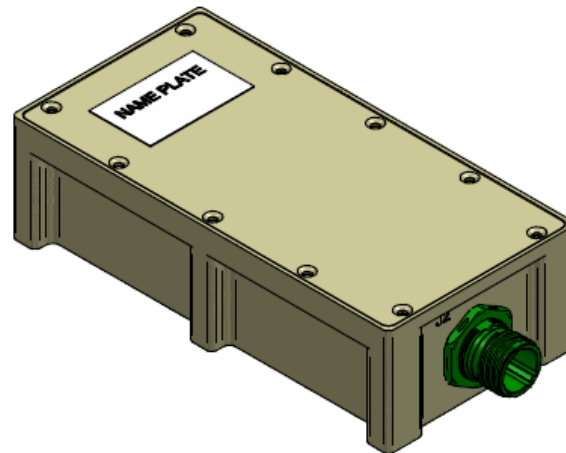

NOTES:

- ① CONNECTORS:
 - 1.1. J1- INPUT CONN 3X#20, P/N D38999/24WA98PN OR EQ.
 - 1.2. J2- OUTPUT CONN. 6X#20 ,P/N D38999/24WB98SN OR EQ.
- ② MATERIALS: AL 6061-T651, AL 5052-H32, OR EQ.
- ③ COATINGS: CHROMATE CONVERSION COATING PER MIL-DTL-5541 TYPE I CLASS 1A.
- ④ WORKMANSHIP SHALL BE MIL-STD-454, REQT. 9.
- ⑤ MAX WEIGHT: TBD [kg].
- ⑥ ENGRAVING:
 - 6.1. CHARACTER HEIGHT: 4.0 mm.
 - 6.2. CHARACTER DEPTH: 0.5mm.
 - 6.3. FONT: ARIAL.
 - 6.4. CHARACTER ARE CENTRALLY LOCATED.
 - 6.5. FILL ENGRAVING WITH BLACK LUSTERLESS EPOXY PAINT, COLOR PER FED-STD 595 NO. 37038.
- ⑦ COOLING: HEAT DISSIPATION AREA- 6,000 [mm²]